



2.4GHz, 802.11 b/g/n

LevelTM Sense PRO

USER MANUAL



www.Level-Sense.com

Contents

About Level Sense Pro	1.0
Device Specifications	1.1
Requirements	1.2
In the Box	1.3
Status LEDs	1.4
Wiring Panel.....	1.5
Installation	2.0
Installation Warning.....	2.1
Mounting to Pump Discharge Pipe ...	2.2
Mounting to the Wall	2.3
Installing Level Sensor.....	2.4
Installing Float Sensor.....	2.5
Installing Leak Sensor	2.6
Powering On	3.0
Connect to Wi-Fi	4.0
Connect with WPS.....	4.1
Connect with Hotspot.....	4.2
Product Registration–Portal.....	5.0
Create Portal Account.....	5.1
Claim Device	5.2
Configure Device Name	5.3
Update Frequency.....	5.4
Offline Threshold.....	5.5
Alarm Inputs	6.0
Per Input Type	6.1 – 6.4
Alarm Outputs.....	7.0
Per Output Type	7.1 – 7.3
Disabling Alarm from Device	7.4
Device and Alarm Testing.....	8.0
Per Device Testing.....	8.1 - 8.5
Maintenance	9.0
Password Reset.....	10.0
Battery Warning.....	11.0
Service Disclaimer.....	12.0
Warranty	13.0
Test Log.....	14.0
Troubleshooting	15.0
Support	16.0

1.0 About Level Sense Pro

Level Sense Pro is a Wi-Fi based residential environmental monitor designed specifically for the home owner who wants to keep a watchful eye on their property at all times. Level Sense Pro monitors five critical elements of the home as alarm inputs—sustained power loss, sump pit high water level, water leak(s), temperature and humidity levels.

Each of the five alarm inputs can be configured individually as alarm triggers based on their state or level. There are three alarm outputs of the Level Sense Pro; email/SMS (text message), audible siren and alarm relay contacts. Additional detail of the alarm outputs can be found in the alarm outputs section of the manual.

Please read the User Manual carefully before using the Level Sense Pro.

1.1 Device Specifications

Operating Temperature: 32-110 F° (0-45 C°)

Temperature Accuracy: $\pm 1^{\circ}\text{F}$ (0.5°C)

Operating Humidity: 0-95% RH, non-condensing

Humidity Accuracy: $\pm 3\%$

Wi-Fi Network: 2.4Ghz Only, 802.11b/g/n

Input Power: 12VDC 700mA

Battery: 3.7V Lithium Ion Polymer 1100mAH *Read Battery Warning

Siren: 100db

Duty: Indoor Only

Antenna: Internally integrated

Sensor Inputs: 2x Dry contact

Relay Contact: 1 Amp Max

Dimensions: 5x6x1.25"

Weight: 2lbs

Contains FCC ID: 2AC7Z-ESP8266EX

1.2 Requirements

120 VAC Power outlet

2.4 Ghz Wi-Fi internet within range of Level Sense

Wi-Fi device with web browsing

Screw Driver, flat head #3 or #4

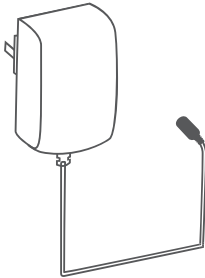
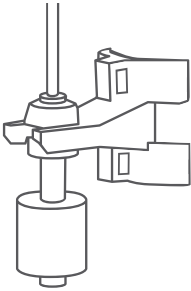
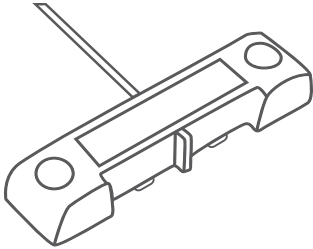
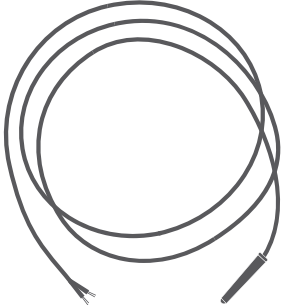
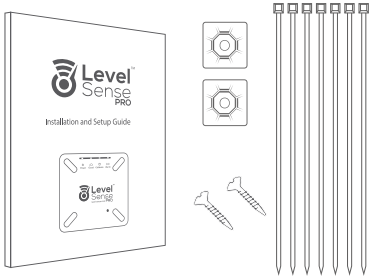

1.3 In the Box

<p>1. Level Sense Pro</p>  <p>The Level Sense Pro device is a square-shaped unit with a white faceplate. At the top, there are four status icons: a power button, a cloud icon for 'Cloud', a gear icon for 'Calibrate', and a bell icon for 'Alarm'. The center features the 'Level Sense PRO' logo with the website 'level-sense.com' below it. There are four mounting slots, one in each corner, and a small circular indicator light at the bottom center.</p>	<p>2. Power Supply</p>  <p>The power supply is a rectangular white box with a power cord on the left side and a long, thin cable extending from the bottom. The cable ends in a small, black, cylindrical connector.</p>
<p>3. Float Switch & Bracket</p>  <p>The float switch and bracket assembly consists of a cylindrical float switch at the bottom, connected to a metal bracket. The bracket has two rectangular slots on its side, likely for mounting to a wall or panel.</p>	<p>4. Leak Sensor</p>  <p>The leak sensor is a long, rectangular, white plastic device with a thin probe extending from one end. It has two circular sensors on the top surface and a small rectangular slot on the side.</p>
<p>5. Level Sensor Wire</p> <p>(Optional Accessory)</p>  <p>The Level sensor wire is a long, thin, black cable that is coiled into a large loop. It has a small, black, cylindrical connector at one end.</p>	<p>6. Accessories</p>  <p>The accessories include an 'Installation and Setup Guide' manual with the Level Sense PRO logo, two circular mounting plates, two screws, and five long, thin metal screws.</p>

1.4 Status LEDs

The status LEDs on the Level Sense Pro provide a visual indication of the control state. The below table is a system status guide. If the four lights have a pattern not shown it is a claim code, and you should reference section 5.2.

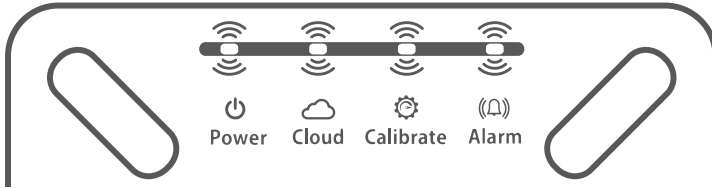

Color / LED	Power	Cloud	Calibrate	Alarm
Blue	Incoming AC Power Good	Connected to Server	Calibrated	No Alarms
Yellow	NO Incoming Power	Flashing: Connecting in Process Solid: WPS Mode	Learning Calibration	
Red	NO Incoming Power	Wrong SSID / Password or unit out-of-range		Active Alarm(s)
White		Hotspot Mode		
Purple		Unit Upgrading Firmware / Server Maintenance		

1.5 Wiring Panel

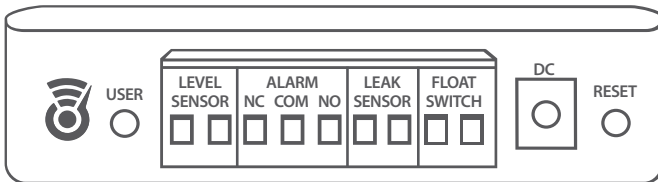

The sensors connect to the removable green terminal block at the bottom of the unit.

Wiring of sensors (level, leak and float switch) have no polarity.

To connect sensors, turn the terminal screw counterclockwise to open the wiring clamp. Insert wire into the clamp and turn terminal screw clockwise to close clamp on wire. Ensure the jaw closes on the conductor and not the insulation of the wire.

Tighten until wire is firmly secured.



2.0 Installation

Level Sense Pro is designed for indoor installation only. The ideal mounting location is in the utility room within a few feet of the sump pump pit. Consideration should be taken to keep within range of the homes Wi-Fi router. Wi-Fi range varies based on the router and environmental conditions. We recommend range testing before installation. If the device is out of range, consider a Wi-Fi range extender. The Level Sense Pro can be mounted in two different ways, choose from the following options.

2.1 Installation Warning

Working around water and electricity is inherently dangerous. Disconnect all electrical circuit breakers near the sump pump and installation area before beginning work. If you are unfamiliar or uncomfortable please contact a licensed electrician to perform the installation.

2.2 Mounting to Pump Discharge Pipe

For most customers, mounting to the discharge pipe of the sump pump, or other nearby PVC pipe, is the simplest installation location. First, install the two self-adhesive mounting squares to the back of the device as shown below. Then, feed a zip tie through the mounting square opening and around the pipe and zip tight. Repeat for the second mounting square. Install the device approximately 1-6 feet above the floor.

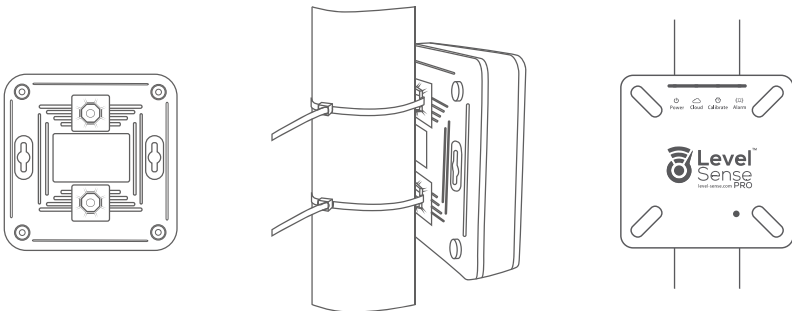

TIP: For larger diameter pipes, connect a second zip tie in series to extend the length of the zip tie.

2.3 Mounting to the Wall

The back side of the Level Sense Pro accepts two #6 screws. The screws are spaced at 3.375" and are mounted horizontally. Install the device approximately 3-6 feet above the floor.

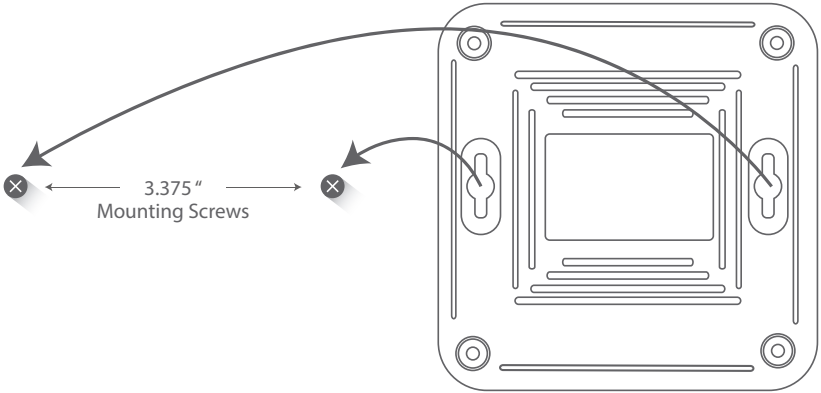

HAVE A QUESTION?

Send us an email: : CustomerService@SumpAlarm.Com or submit a request through our webpage: <http://www.level-sense.com/pages/support>



Contact support
CustomerService@SumpAlarm.Com
or Phone: 314-787-8059



2.4 Installing Level Sensor (Optional Accessory)

The level sensor is used to help determine pump cycle frequency. This sensor is not required and only provides an approximation of water level following a calibration process. This is useful if you are unsure how often your pump runs. High water alarms are triggered from the float sensor.

The level sensor is installed vertically on the PVC discharge pipe of the sump pump. The sensor wire attaches to the PVC pipe with zip ties. Place the sealed end of the sensor wire as far down the pipe as possible. The closer the sealed end of the wire is to the bottom of the pipe, the more resolution of water level you will see. Care must be taken to secure the sensor wire to the discharge pipe to avoid it being sucked into the pump. Don't allow the sensor wire to come in contact with the power cable of the sump pump or metal piping as this can skew the reading. Do not modify level sensor wire length.

Water level data will take some time to appear in the portal. The calibration process waits until it sees several cycles of minimum and maximum levels before it can begin presenting data. If your level graphs are "solid blue" wait until a period of heavy rain and click the button in the portal that says "RESTART CALIBRATION PROCESS".

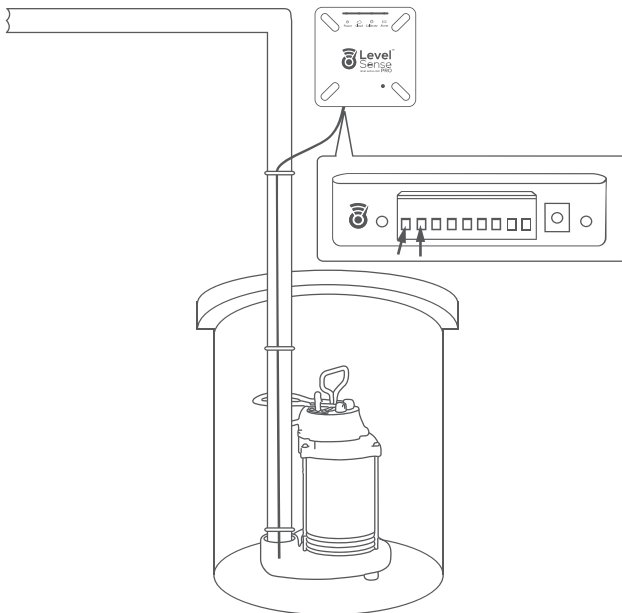

2.5 Installing Float Sensor

The float sensor mounts above the normal pump water line and detects when the water level has reached a point above normal operating range.

The float sensor installs on the sump pump discharge pipe. Using the provided plastic float bracket and two zip ties, securely mount the float to the discharge pipe. The sliding float portion of the sensor should face down. Mount the float approximately six (6) inches above the sump pump normal water line. This level can usually be found by looking at the side walls of the pit to visually see the high water mark roughly level with the top of the pump. The wires from the float sensor connect to the far right two terminals on the Level Sense Pro. The wires do not have polarity, and cannot be wired backwards. Do not increase wire length beyond the length provided.

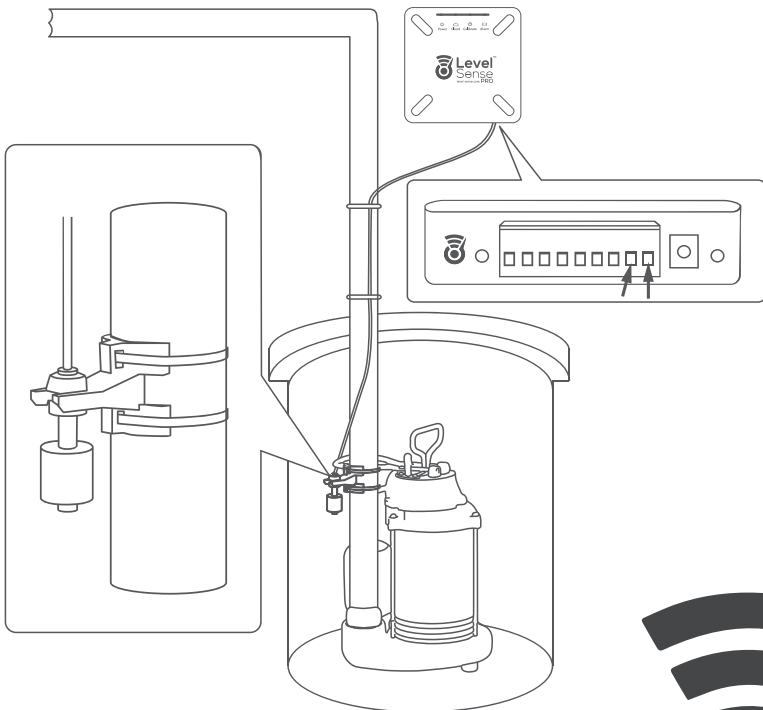

2.6 Installing Leak Sensor (Optional Accessory)

The leak sensor monitors for pooling water on a flat surface, this sensor does not need to be installed if this type of monitoring is not required.

The leak sensor can be mounted near the sump pit or other area where water would pool in the event of a leak. Typical locations are near a water heater or HVAC system which could leak during a malfunction. The sensor needs to be placed flat on the floor with the metal sensing elements down. The sensor must be submerged in a minimum pool of water 1/8" in depth before activating. The wires do not have polarity, and cannot be wired backwards. Do not increase wire length of the leak sensor beyond the length provided.

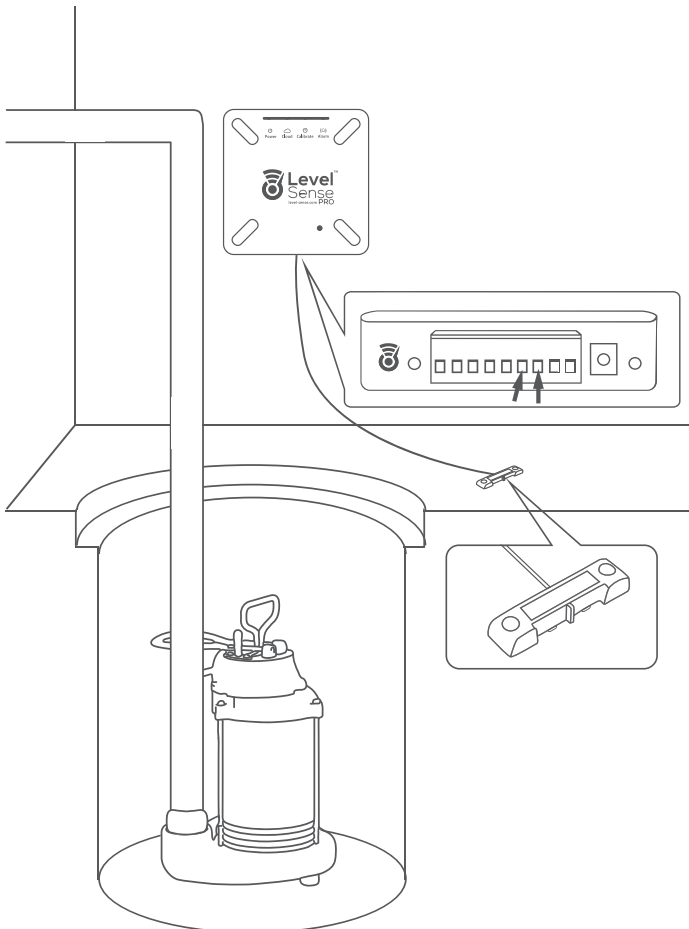

3.0 Powering On

After mounting the Level Sense Pro control unit and successful installation of sensors we can now power up the control unit. First, connect the DC jack of the power supply to the Level Sense Pro control. Second, connect the AC wall adapter to a standard 120VAC power outlet. Use only the supplied power adapter.

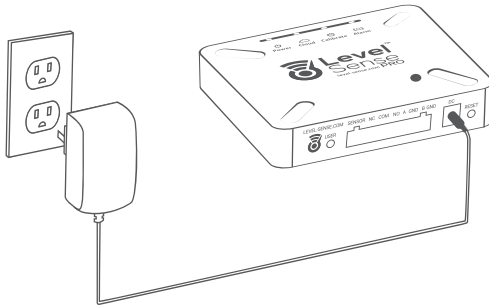

Upon power up, the cloud LED indicator will begin to pulse white.

4.0 Connect to Wi-Fi

The Level Sense Pro is immediately ready to join your 2.4 Ghz Wi-Fi network after power up. When the Level Sense Pro has no configured Wi-Fi, the cloud LED will pulse white.

There are two methods of connecting to a home network depending on your Wi-Fi router. The preferred method is using a process called WPS or Wi-Fi Protected Setup. The second method turns the Level Sense Pro into a hotspot which you temporarily join with a smart device to configure Wi-Fi credentials. There are a series of articles on more advanced troubleshooting for WiFi Connections on the Level Sense website at:

<https://www.Level-Sense.Com/TroubleShooting>

Password Requirements for Your Local 2.4Ghz Wi-Fi Network:
SSID (Local Network Name) and Password are Case Sensitive
You must have a password 8 – 48 Characters in Length
Cannot Contain Special Characters, such as: !@#\$\$%^&*()?

THIS APPLIES TO CONNECTING WITH WPS OR CONNECTING WITH HOTSPOT!



4.1 Connect with WPS



To connect to Wi-Fi with WPS, first check to see your Wi-Fi router has a button labeled “WPS.” (Generally denoted with the graphic above.) If your router does not, proceed to connecting with hotspot mode. Some routers require WPS to be enabled, or direct it to a particular channel (i.e. 2.4 GHz or 5 GHz). Temporarily move the Level Sense Pro control unit into close proximity of the Wi-Fi router. The Level Sense Pro will operate on battery backup to complete this step if allowed to charge for 30 minutes prior. Once the two devices are near each other, press the WPS button on your router first. Within 15 seconds, double click the USER button on the Level Sense Pro. The Cloud LED will turn from pulsing white to solid yellow. The WPS process can take up to three minutes. Upon successful connection, all four LEDs will illuminate and pulse. Please note the colors from left to right as they are used later in the claim process, section 5.2. You have successfully connected to your home Wi-Fi, please move on to Product Registration.

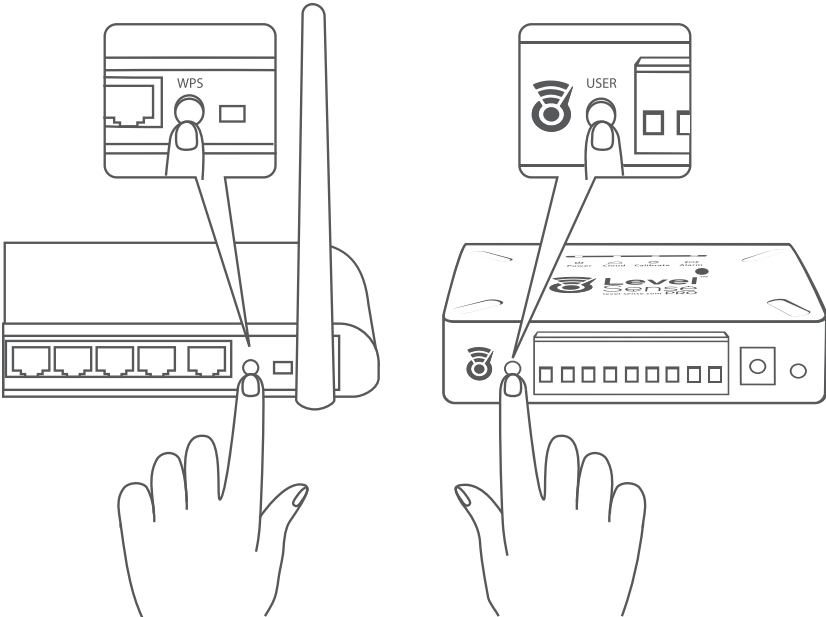

TIP: If the Cloud LED turns red following a WPS attempt, press the RESET button to restart the device. If the Cloud LED returns to red after restarting, check your router settings to see if WPS is enabled. Alternatively, try connecting with hotspot mode.

4.2 Connect with Hotspot

To connect to Wi-Fi with hotspot mode you will need a Wi-Fi enabled device like a smart phone or laptop. The cloud LED of the Level Sense Pro should be pulsing white, which indicates the device is broadcasting a Wi-Fi hotspot. If you are using a smart phone or tablet with a cellular connection, it is good practice to turn cellular data off for this process. Use your Wi-Fi device to search for and join the network called "Level-Sense." You can learn more about joining a Wi-Fi network by referring to the user manual of your device. Once connected to the network "Level-Sense," open a web browser and navigate to the address: **192.168.4.1**

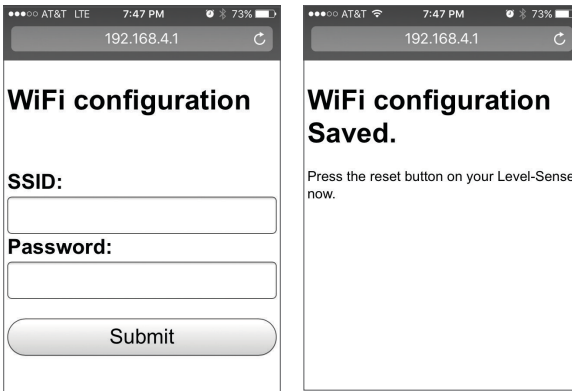

On the webpage at 192.168.4.1 you will provide Wi-Fi SSID (Network name) and password. Both fields are case sensitive. Once complete, press the submit button. The next webpage instructs you to reset the device by pressing the RESET button on the Level Sense Pro. After restarting, the Cloud LED will pulse yellow until it connects to your Wi-Fi. Upon successful connection, all four LEDs will pulse. Please note the colors from left to right as they are used later in the claim process, section 5.2. You have successfully connected to your home Wi-Fi, please move on to Product Registration.

NOTE: If all four LEDs do not illuminate, and the Cloud LED turns red, the SSID or password is entered incorrectly. Refer to Password Reset, section 10.0, of the manual.



5.0 Product Registration–Portal

The Level Sense Pro is set up and managed via a cloud service called Portal. To access the Level Sense Portal, you first need to create an account. With an account, you can claim your device, setup alarm contacts and set alarms.

5.1 Create Portal Account

Using an internet browser, preferably on a laptop or desktop, navigate to the Level Sense Portal:

<https://www.Level-Sense.com> and click on PORTAL.

Password Requirements for Level Sense Portal:
You Must Have a Password
Any Length above 8 Characters
Special Characters Allowed

Within Portal, click “Register” to create an account. You will need to provide a valid email address. Within 5 minutes of registration, you will receive a confirmation email. If you have not received an email please check your spam folder for an email from alarm@level-sense.com.

5.2 Claim Device

Once connected to Wi-Fi, the Level Sense Pro flashes a claim code which is used to link the device to your account. The claim code is a sequence of four unique colors.

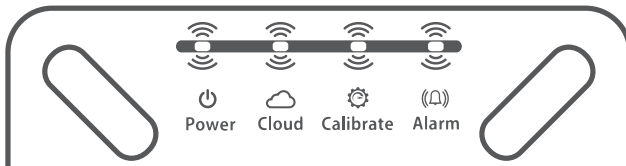

After logging into Portal with your account, click “Claim.” Follow the on screen instructions to enter your unique claim code.

5.3 Configure Device Name

By default, the Level Sense Pro is named “New Sensor” in the Portal. The device name can be modified and is useful if you have multiple devices in your Portal.

5.4 Update Frequency

Set the update frequency between two minutes (default) and five minutes. Configuring for less frequent updates consumes less Wi-Fi data.

5.5 Offline Threshold

The offline threshold is how long our system will wait after it loses connection with your device to send out an alert. The lower the number of minutes is, the more notifications you will receive. We recommend a minimum of 10 minutes (or 5 times the Update Frequency).

6.0 Alarm Inputs

By default, all sensor inputs are enabled. Disable sensor inputs to suit your application. Sensors can be re-enabled at a later point.

6.1 Temperature and Humidity Alarm

Configure a safe temperature and humidity range by setting minimum and maximum safe levels. Alarms will occur when levels are outside of these bounds.

6.2 Power Loss Alarm

An alarm will occur after 60 seconds of power failure. If Wi-Fi connection is lost due to widespread power failure or lost Wi-Fi, an alarm message cannot be sent. However, Portal will send a device offline message after the device misses multiple consecutive check-ins. Using default settings, a device offline message is issued within 6-8 minutes of going offline. Device offline reminders are sent after 24 hours, 3 days, and 7 days of continued failed check-ins.

6.3 Float Switch Alarm

The float switch will alarm when water lifts the sensor float bobber for more than 10 seconds.

6.4 Leak Sensor Alarm

The leak sensor will alarm when the sensor is in a minimum water pool of 1/8" " for more than 10 seconds.



7.0 Alarm Outputs

Alarm outputs are set up based on each sensor input. By default, all sensors have all alarm outputs enabled. If the sensor input is enabled, it can have alarm outputs. You can disable inputs and outputs to suit your application and to match your installation configuration. The Alarm LED will turn red when there is an alarm and blue when there are no alarms.

7.1 Audible Alarm (Siren)

Enable the audible alarm for an audible warning. The audible alarm can be temporarily silenced by pressing the USER button.

7.2 Message Alarm (Text/Email)

In the portal click on CONTACTS. Enable the message alarm to receive alerts to your smart device via SMS and/or email. Use the test function within Portal to confirm each recipient. If using email and you do not receive the message, check your spam folder. You might need to configure spam settings to allow e-mails from alarm@level-sense.com.

7.3 Relay Alarm

Enable the relay alarm to have the dry contact relay change states on alarm event. The relay is a latching type and will maintain its state even when the power fails and after the battery has drained. The alarm relay is useful when connecting the Level Sense Pro into a home security system. Both NO and NC contacts are available for increased wiring applications.

7.4 Silencing an Alarm on the Device

Alarms can be temporarily disabled by pressing the USER button on the Level Sense Pro control. This is particularly useful to silence the audible alarm once you are aware of the alarm. This will disable the alarm until it has been cleared and then reoccurs. As an example, if you silence a temperature alarm, it will not alarm again until temperature goes back into the non-alarm range, and then returns into alarm range. If multiple alarms are disabled, all alarm inputs must be cleared before it will alarm again.

8.0 Device and Alarm Testing

The Level Sense Pro and sensors should be tested monthly to ensure proper operation.

8.1 Humidity and Temperature Testing

Testing for temperature and humidity sensors is done by comparing current levels in Portal with a calibrated reference. Readings of +/-3% are expected.

8.2 Float Switch Testing

Test the float switch by holding the float up, simulating high water, and waiting 60 seconds for an alarm. Release the float after testing.

8.3 Leak Sensor Testing

Test the leak sensor by dipping both metal tabs of the sensor into a cup of water and waiting 60 seconds for an alarm. Do not submerge the plastic housing of the sensor. Dry the metal tabs and replace the sensor after testing.

8.4 Power Loss Detection Testing

Test power loss detection by removing the power adapter from the wall and waiting for alarm. Reconnect the power adapter after testing.

8.5 Battery Condition Testing

Remove the power adapter from the wall and allow the device to run for three hours on the internal battery pack. If the device turns off before three hours replace the battery. Dispose battery according to local rules and regulations.

9.0 Maintenance

Level Sense Pro and sensors require the following monthly maintenance steps. Wipe the control off with a damp cloth. Inspect the leak sensor contacts for corrosion and clean or replace if necessary. Check the float sensor can travel freely. Check the level sensor has not come loose from the PVC pipe. Check for fraying wire, loose connections or other general wear and replace if necessary.



10.0 Password Reset

To clear the Wi-Fi credentials from the Level Sense Pro, complete the following password reset steps:

- Press and hold the USER button until all four LEDs turn solid red. (If after 10 seconds they have not turned red, release the button for a few seconds and try again. It can take several attempts to get into password reset mode.)
- Once all four LEDs turn red, click the USER button until two LEDs have turned off and two remain lit, usually this requires two button clicks.
- Wait until the two red lights go out ten seconds and press the RESET button. The password reset is complete.

A red cloud LED following hotspot mode setup typically means an incorrect SSID or password. Remember, these fields are case sensitive. Use password reset to return the device to hotspot mode and repeat the hotspot setup steps.

11.0 Battery Warning

Level Sense Pro contains a Lithium Ion Polymer battery which can be volatile. Damaged or misused batteries can result in fire, personal injury and damage to property. Please handle the device carefully, never drop or subject the device to harsh movements or environments. If the product is damaged in shipping, please quarantine the device and contact us immediately. If you suspect you have a damaged battery, place it in a safe open space and observe the battery for approximately 15 minutes. A battery may swell or even possibly catch fire after a short time.

By using the Level Sense Pro, the buyer assumes all risks associated Lithium Ion Polymer batteries. If you do not agree with these conditions, return the device immediately before use.

Replace the battery after 300-500 full or partial discharges or three years, whichever occurs sooner. Only use batteries from Level Sense.

12.0 Service Disclaimer

Level Sense includes a minimum cloud monitoring service ("Portal") period of one year from the date of manufacture. Continued service may be offered monthly or annually for a fee or gratis. Level Sense reserves the right to alter, amend or change information, services and pricing at any time. Level Sense also reserves the right to modify or discontinue services at any time after the first year.

13.0 Warranty

2 YEAR LIMITED WARRANTY

PLEASE READ THIS WARRANTY CAREFULLY BEFORE USING THE PRODUCT.

THIS LIMITED WARRANTY CONTAINS THE STANDARD TERMS AND CONDITIONS (“TOC”) OF LEVEL SENSE. WHERE PERMITTED BY THE APPLICABLE LAW, BY KEEPING YOUR LEVEL SENSE PRODUCT BEYOND THIRTY (30) DAYS AFTER THE DATE OF DELIVERY, YOU FULLY ACCEPT THE TERMS AND CONDITIONS SET FORTH IN THIS LIMITED WARRANTY.

IN ADDITION, WHERE PERMITTED BY THE APPLICABLE LAW, YOUR INSTALLATION AND/OR USE OF THE PRODUCT CONSTITUTES FULL ACCEPTANCE OF THE TERMS AND CONDITIONS OF THIS LIMITED WARRANTY (HEREINAFTER REFERRED TO AS “LIMITED WARRANTY OR WARRANTY”). IF YOU DO NOT AGREE TO THE TERMS AND CONDITIONS OF THIS WARRANTY, INCLUDING ANY LIMITATIONS OF WARRANTY, INDEMNIFICATION TERMS OR LIMITATION OF LIABILITY, THEN YOU SHOULD NOT USE THE PRODUCT AND SHOULD RETURN IT TO THE SELLER FOR A REFUND OF THE PURCHASE PRICE. THE LAW MAY VARY BY JURISDICTION AS TO THE APPLICABILITY OF YOUR INSTALLATION OR USE ACTUALLY CONSTITUTING ACCEPTANCE OF THE TERMS AND CONDITIONS HEREIN AND AS TO THE APPLICABILITY OF ANY LIMITATION OF WARRANTY, INDEMNIFICATION TERMS OR LIMITATIONS OF LIABILITY.

- 1. WARRANTOR:** IN THIS WARRANTY, WARRANTOR SHALL MEAN “DEALER, DISTRIBUTOR, AND/OR MANUFACTURER.”
- 2. ELEMENTS OF WARRANTY:** THIS PRODUCT IS WARRANTED TO BE FREE FROM DEFECTS IN MATERIALS AND CRAFTSMANSHIP WITH ONLY THE LIMITATIONS AND EXCLUSIONS SET OUT BELOW.
- 3. WARRANTY AND REMEDY:** TWO-YEAR WARRANTY – IN THE EVENT THAT THE PRODUCT DOES NOT CONFORM TO THIS WARRANTY AT ANY TIME DURING THE TIME OF TWO YEARS FROM ORIGINAL PURCHASE, WARRANTOR WILL REPAIR THE DEFECT AND RETURN IT TO YOU AT NO CHARGE.

THIS WARRANTY SHALL TERMINATE AND BE OF NO FURTHER EFFECT AT THE TIME THE PRODUCT IS: (1) DAMAGED BY EXTERNAL CAUSES SUCH AS FIRE, WATER, LIGHTNING, ETC. OR NOT MAINTAINED AS REASONABLE AND NECESSARY; OR (2) MODIFIED; OR (3) IMPROPERLY INSTALLED; OR (4) MISUSED; OR (5) REPAIRED OR SERVICED BY SOMEONE OTHER THAN WARRANTORS’ AUTHORIZED PERSONNEL OR SOMEONE EXPRESSLY AUTHORIZED BY WARRANTOR’S TO MAKE SUCH SERVICE OR REPAIRS; (6) USED IN A MANNER OR PURPOSE FOR WHICH THE PRODUCT WAS NOT INTENDED; OR (7) SOLD BY ORIGINAL PURCHASER.

LIMITED WARRANTY, LIMITATION OF DAMAGES AND DISCLAIMER OF LIABILITY FOR DAMAGES: THE WARRANTOR’S OBLIGATION UNDER THIS WARRANTY IS LIMITED TO REPAIR OR REPLACEMENT OF THE PRODUCT, AT THE WARRANTOR’S OPTION AS TO REPAIR OR REPLACEMENT. IN NO EVENT SHALL WARRANTORS BE LIABLE OR RESPONSIBLE FOR PAYMENT OF ANY INCIDENTAL, CONSEQUENTIAL, SPECIAL AND/OR PUNITIVE DAMAGES OF ANY KIND, INCLUDING BUT NOT LIMITED TO ANY LABOR COSTS, PRODUCT COSTS, LOST REVENUE, BUSINESS INTERRUPTION LOSSES, LOST PROFITS, LOSS OF BUSINESS, LOSS OF DATA OR INFORMATION, OR FINANCIAL LOSS, FOR CLAIMS OF ANY NATURE, INCLUDING BUT NOT LIMITED TO CLAIMS IN CONTRACT, BREACH OF WARRANTY OR TORT, AND WHETHER OR NOT CAUSED BY WARRANTORS’ NEGLIGENCE. IN THE EVENT THAT IT IS DETERMINED IN ANY ADJUDICATION THAT THE LIMITED WARRANTIES OF REPAIR OR REPLACEMENT ARE INAPPLICABLE, THEN THE PURCHASER’S SOLE REMEDY SHALL BE PAYMENT TO THE PURCHASER OF THE ORIGINAL COST OF THE PRODUCT, AND IN NO EVENT SHALL WARRANTORS BE LIABLE OR RESPONSIBLE FOR PAYMENT OF ANY INCIDENTAL, CONSEQUENTIAL, SPECIAL AND/OR PUNITIVE DAMAGES OF ANY KIND, INCLUDING BUT NOT LIMITED TO ANY LOST REVENUE, BUSINESS INTERRUPTION LOSSES, LOST PROFITS, LOSS OF BUSINESS, LOSS OF DATA OR INFORMATION, OR FINANCIAL LOSS, FOR CLAIMS OF ANY NATURE, INCLUDING BUT NOT LIMITED TO CLAIMS IN CONTRACT, BREACH OF WARRANTY OR TORT, AND WHETHER OR NOT CAUSED BY WARRANTORS’ NEGLIGENCE.



WITHOUT WAIVING ANY PROVISION IN THIS LIMITED WARRANTY, IF A CIRCUMSTANCE ARISES WHERE WARRANTORS ARE FOUND TO BE LIABLE FOR ANY LOSS OR DAMAGE ARISING OUT OF MISTAKES, NEGLIGENCE, OMISSIONS, INTERRUPTIONS, DELAYS, ERRORS OR DEFECTS IN WARRANTORS' PRODUCTS OR SERVICES, SUCH LIABILITY SHALL NOT EXCEED THE TOTAL AMOUNT PAID BY THE CUSTOMER FOR WARRANTORS' PRODUCT AND SERVICES OR \$150.00, WHICHEVER IS GREATER. YOU HEREBY RELEASE WARRANTORS FROM ANY AND ALL OBLIGATIONS, LIABILITIES AND CLAIMS IN EXCESS OF THIS LIMITATION.

INDEMNIFICATION AND COVENANT NOT TO SUE: YOU WILL INDEMNIFY, DEFEND AND HOLD HARMLESS WARRANTORS, THEIR OWNERS, DIRECTORS, OFFICERS, EMPLOYEES, AGENTS, SUPPLIERS OR AFFILIATED COMPANIES, AGAINST ANY AND ALL CLAIMS, DEMANDS OR ACTIONS BASED UPON ANY LOSSES, LIABILITIES, DAMAGES OR COSTS, INCLUDING BUT NOT LIMITED TO DAMAGES THAT ARE DIRECT OR INDIRECT, INCIDENTAL, SPECIAL OR CONSEQUENTIAL, AND INCLUDING ATTORNEYS FEES AND LEGAL COSTS, THAT MAY RESULT FROM THE INSTALLATION, OPERATION, USE OF, OR INABILITY TO USE WARRANTORS' PRODUCTS AND SERVICES, OR FROM THE FAILURE OF THE WARRANTORS' SYSTEM TO REPORT A GIVEN EVENT OR CONDITION, WHETHER OR NOT CAUSED BY WARRANTORS' NEGLIGENCE.

YOU AGREE TO RELEASE, WAIVE, DISCHARGE AND COVENANT NOT TO SUE WARRANTORS, THEIR OWNERS, DIRECTORS, OFFICERS, EMPLOYEES, AGENTS, SUPPLIERS OR AFFILIATED COMPANIES, FOR ANY AND ALL LIABILITIES POTENTIALLY ARISING FROM ANY CLAIM, DEMAND OR ACTION BASED UPON ANY LOSSES, LIABILITIES, DAMAGES OR COSTS, INCLUDING BUT NOT LIMITED TO DAMAGES THAT ARE DIRECT OR INDIRECT, INCIDENTAL, SPECIAL OR CONSEQUENTIAL, AND INCLUDING ATTORNEYS FEES AND LEGAL COSTS, THAT MAY RESULT FROM THE INSTALLATION, OPERATION, USE OF, OR INABILITY TO USE WARRANTORS' PRODUCTS AND SERVICES, OR FROM THE FAILURE OF THE WARRANTORS' SYSTEM TO REPORT A GIVEN EVENT OR CONDITION, WHETHER OR NOT CAUSED BY WARRANTORS' NEGLIGENCE, EXCEPT AS NECESSARY TO ENFORCE THE EXPRESS TERMS OF THIS LIMITED WARRANTY.

EXCLUSIVE WARRANTY: THE LIMITED WARRANTY OR WARRANTIES DESCRIBED HEREIN CONSTITUTE THE SOLE WARRANTY OR WARRANTIES TO THE PURCHASER. ALL IMPLIED WARRANTIES ARE EXPRESSLY DISCLAIMED, INCLUDING: THE WARRANTY OF MERCHANTABILITY AND THE WARRANTY OF FITNESS FOR A PARTICULAR USE AND THE WARRANTY OF FITNESS FOR A PARTICULAR PURPOSE AND THE WARRANTY OF NON-INFRINGEMENT AND/OR ANY WARRANTY ARISING FROM A COURSE OF DEALING, USAGE, OR TRADE PRACTICE.

IT MUST BE CLEAR THAT THE WARRANTORS ARE NOT INSURING YOUR PREMISES OR BUSINESS OR GUARANTEEING THAT THERE WILL NOT BE DAMAGE TO YOUR PERSON OR PROPERTY OR BUSINESS IF YOU USE THIS PRODUCT. YOU SHOULD MAINTAIN INSURANCE COVERAGE SUFFICIENT TO PROVIDE COMPENSATION FOR ANY LOSS, DAMAGE, OR EXPENSE THAT MAY ARISE IN CONNECTION WITH THE USE OF PRODUCTS OR SERVICES, EVEN IF CAUSED BY WARRANTORS' NEGLIGENCE. THE WARRANTORS ASSUME NO LIABILITY FOR INSTALLATION OF THE PRODUCT AND/OR INTERRUPTIONS OF THE SERVICE DUE TO STRIKES, RIOTS, FLOODS, FIRE, AND/OR ANY CAUSE BEYOND SELLER'S CONTROL, FURTHER SUBJECT TO THE LIMITATIONS EXPRESSED IN ANY LICENSE AGREEMENT OR OTHER AGREEMENT PROVIDED BY WARRANTORS TO PURCHASER.

THE AGREEMENT BETWEEN THE WARRANTORS AND THE PURCHASER, INCLUDING BUT NOT LIMITED TO THE TERMS AND CONDITIONS HEREIN SHALL NOT BE GOVERNED BY THE CONVENTION FOR THE INTERNATIONAL SALE OF GOODS. WHERE APPLICABLE, THE UNIFORM COMMERCIAL CODE AS ADOPTED BY THE STATE OF DELAWARE SHALL APPLY.

- 4. PROCEDURE FOR OBTAINING PERFORMANCE OF WARRANTY:** IN THE EVENT THAT THE PRODUCT DOES NOT CONFORM TO THIS WARRANTY, THE PRODUCT SHOULD BE SHIPPED OR DELIVERED FREIGHT PREPAID TO A WARRANTOR WITH EVIDENCE OF ORIGINAL PURCHASE.
- 5. LEGAL REMEDIES AND DISCLAIMER:** SOME JURISDICTIONS MAY NOT ALLOW, OR MAY PLACE LIMITS UPON, THE EXCLUSION AND/OR LIMITATION OF IMPLIED WARRANTIES, INCIDENTAL DAMAGES AND/OR CONSEQUENTIAL DAMAGES FOR SOME TYPES OF GOODS OR PRODUCTS SOLD TO CONSUMERS AND/OR THE USE OF INDEMNIFICATION TERMS. THUS, THE EXCLUSIONS, INDEMNIFICATION TERMS AND LIMITATIONS SET OUT ABOVE MAY NOT APPLY, OR MAY BE LIMITED IN THEIR APPLICATION, TO YOU. IF THE IMPLIED WARRANTIES CAN NOT BE EXCLUDED, AND THE APPLICABLE LAW PERMITS LIMITING THE DURATION OF IMPLIED WARRANTIES, THEN THE IMPLIED WARRANTIES HEREIN ARE TO BE LIMITED TO THE SAME DURATION AS THE APPLICABLE WRITTEN WARRANTY OR WARRANTIES HEREIN. THE WARRANTY OR WARRANTIES HEREIN MAY GIVE YOU SPECIFIC LEGAL RIGHTS THAT WILL DEPEND UPON THE APPLICABLE LAW. YOU MAY ALSO HAVE OTHER LEGAL RIGHTS DEPENDING UPON THE LAW IN YOUR JURISDICTION.
- 6. CHOICE OF FORUM AND CHOICE OF LAW:** IN THE EVENT THAT A DISPUTE ARISES OUT OF OR IN CONNECTION WITH THIS LIMITED WARRANTY, THEN ANY CLAIMS OR SUITS OF ANY KIND CONCERNING SUCH DISPUTES SHALL ONLY AND EXCLUSIVELY BE BROUGHT IN EITHER THE EASTERN DISTRICT COURT OF MISSOURI OR THE UNITED STATES DISTRICT COURT FOR THE EASTERN DISTRICT OF MISSOURI.

REGARDLESS OF THE PLACE OF CONTRACTING OR PERFORMANCE, THIS LIMITED WARRANTY AND ALL QUESTIONS RELATING TO ITS VALIDITY, INTERPRETATION, PERFORMANCE AND ENFORCEMENT SHALL BE GOVERNED BY AND CONSTRUED IN ACCORDANCE WITH THE LAWS OF THE STATE OF MISSOURI, WITHOUT REGARD TO THE PRINCIPLES OF CONFLICTS OF LAW.

Effective date 01/11/2019

Sump Alarm, Inc. d.b.a. Level Sense

Phone: 314-787-8059



15.0 Troubleshooting

There are a series of articles on more advanced troubleshooting on the Level Sense Website at <https://Level-Sense.Com> then click "Troubleshoot". Here you can find information for more advanced issues on Wi-Fi connectivity.

Wi-Fi will not stay connected: Device out of range. Check router antennas are not blocked and router is optimally placed within house.

Wi-Fi will not connect: Assuming the device is within range of the router, check network SSID and password. Refer to Password Reset, section 10.0, of the manual.

Email messages and test email not received: Check the spam message folder for message from alarm@level-sense.com.

False high water float switch readings: Check placement of switch relative to normal high water line. Slide float and bracket assembly up so sensor will not activate until water is at a higher level.

False leak or float switch alarm: Check sensor wires are not in close proximity to high voltage pump wires. This can cause the sensor to have false readings.

Water Level Graphs Not Rendering Properly: Wait until a heavy rain (or put a hose into your sump), and then restart the calibration process in the Portal.

16.0 Support

HAVE A QUESTION?

Send us an email to: CustomerService@SumpAlarm.Com or submit a request through our webpage: <http://www.Level-Sense.com/pages/support>



Contact support

CustomerService@SumpAlarm.Com
or Phone: 314-787-8059





www.Level-Sense.com

